



***dirt rocket***  
***MX500 & MX650***



# OWNER'S MANUAL

**Read and understand this entire manual before riding!  
DO NOT RETURN TO STORE!**

**NOTE: Manual illustrations are for demonstration purposes only.  
Illustrations may not reflect exact appearance of actual product.  
Specifications subject to change without notice.**

# CONTENTS

Safety Warnings .....	1	MX500 / MX650 Parts .....	10
Before You Begin.....	2	Safety Reminders .....	13
Assembly and Set-Up.....	3-4	Warranty Information.....	13
Repair and Maintenance.....	5-8		
Troubleshooting Guide .....	9-10		

# SAFETY WARNINGS

**⚠ WARNING:** Riding an electric motorbike can be a hazardous activity. Certain conditions may cause the equipment to fail without fault of the manufacturer. Like other electric products, the Dirt Rocket can and is intended to move, and it is therefore possible to lose control, fall off and/or get into dangerous situations that no amount of care, instruction or expertise can eliminate. If such things occur you can be seriously injured or die, even when using safety equipment and other precautions. **RIDE AT YOUR OWN RISK AND USE COMMON SENSE.**

This manual contains many warnings and cautions concerning the consequences of failing to maintain, inspect or properly use your electric motorbike. Because any incident can result in serious injury or even death, we do not repeat the warning of possible serious injury or death each time such a possibility is mentioned.

## APPROPRIATE RIDER USE AND PARENTAL SUPERVISION

This manual contains important safety information. It is your responsibility to review this information and make sure that all riders understand all warnings, cautions, instructions and safety topics and assure that young riders are able to safely and responsibly use this product. Razor USA recommends that you periodically review and reinforce the information in this manual with younger riders, and that you inspect and maintain your children's product to insure their safety.

The recommended rider age (14 for the MX500 and 16 for the MX650) is only an estimate, and can be affected by the rider's size, weight or skills. Any rider unable to fit comfortably on the Dirt Rocket should not attempt to ride it.

**A parent's decision to allow his or her child to ride this product should be based on the child's maturity, skill and ability to follow rules.**

Keep this product away from small children and remember that this product is intended for use only by persons who are, at a minimum, completely comfortable and competent while operating the product.

DO NOT EXCEED THE WEIGHT LIMIT OF 175 pounds for the MX500 and 220 pounds for the MX650. Rider weight does not necessarily mean a person's size is appropriate to fit or maintain control of the Dirt Rocket.

Do not touch the brakes or electric motor on your electric motorbike when in use as they can become very hot.

Refer to the section on safety for additional warnings.

## ACCEPTABLE RIDING PRACTICES AND CONDITIONS

**Always check and obey any local laws or regulations which may affect the locations where the Dirt Rocket may be used.**

Ride defensively. Watch out for potential obstacles that could catch your wheel or force you to swerve suddenly or lose control. Be careful to avoid pedestrians, skaters, skateboards, scooters, bikes, children or animals who may enter your path, and respect the rights and property of others.

The Dirt Rocket is meant to be used only in controlled environments free of potential traffic hazards and not on public streets or sidewalks. Do not ride your electric motorbike in any areas where pedestrian or product traffic is present.

Do not activate the speed control on the hand grip unless you are on the electric motorbike and in a safe, outdoor environment suitable for riding.

These bikes were manufactured for performance and durability but are not impervious to damage. Jumping or other aggressive riding can over-stress and

damage any product, including the electric motorbike, and the rider assumes all risks associated with high-stress activity.

Be careful and know your limitations. Risk of injury increases as the degree of riding difficulty increases. The rider assumes all risk associated with aggressive riding activities.

Maintain a hold on the handlebars at all times.

Never carry passengers or allow more than one person at a time to ride the electric motor bike.

Never use near steps or swimming pools.

Keep your fingers and other body parts away from the drive chain, steering system, wheels and all other moving components.

Never use headphones or a cell phone when riding.

Never hitch a ride with another product.

Do not ride the Dirt Rocket in wet or icy weather and never immerse the electric motorbike in water, as the electrical and drive components could be damaged by water or create other possibly unsafe conditions.

The Dirt Rocket is intended for use on flat, level ground without loose debris such as rocks or gravel. Wet, slick, bumpy, uneven or rough surfaces may impair traction and contribute to possible accidents. Do not ride the electric motorbike in mud, ice, puddles or water. Avoid excessive speeds that can be associated with downhill rides. Never risk damaging surfaces such as carpet or flooring by use of an electric motorbike indoors.

Do not ride at night or when visibility is limited.

## PROPER RIDING ATTIRE

Always wear proper protective equipment such as an approved safety helmet (with chin strap securely buckled), elbow pads and kneepads. A helmet may be legally required by local law or regulation in your area. A long-sleeved shirt, long pants and gloves are recommended. Always wear athletic shoes (lace-up shoes with rubber soles), never ride barefooted or in sandals, and keep shoelaces tied and out of the way of the wheels, motor and drive system.

## USING THE CHARGER

The charger supplied with the electric motorbike should be regularly examined for damage to the cord, plug, enclosure and other parts, and in the event of such damage, the bike must not be charged until the charger has been repaired or replaced.

Use only with the recommended charger.

Use caution when charging.

The charger is not a toy. Charger should be operated by an adult.

Do not operate near flammable materials.

Unplug charger and disconnect from bike when not in use.

Always disconnect from the charger prior to wiping down and cleaning your electric motorbike with liquid.

**FAILURE TO USE COMMON SENSE AND HEED THE ABOVE WARNINGS INCREASES RISK OF SERIOUS INJURY. USE WITH APPROPRIATE CAUTION AND SERIOUS ATTENTION TO SAFE OPERATION.**

# BEFORE YOU BEGIN

Remove contents from box. Remove the foam separators that protect the components from damage during shipping. Inspect the contents of the box for scratches in the paint, dents or kinked cables that may have occurred during shipping. Because the Dirt Rocket is 95 percent assembled and packed at the factory, there should not be any problems, even if the box has a few scars or dents.

**MAKE SURE POWER SWITCH IS TURNED "OFF" BEFORE CONDUCTING ANY MAINTENANCE PROCEDURES.**

## Estimated Assembly and Set-Up Time

Razor recommends assembly by an adult.

Allow up to 30 minutes for assembly.

Allow up to 18 hours for initial charge (see page 3 for charging information).

**WARNING:**  
DO NOT USE NON-RAZOR PRODUCTS WITH YOUR RAZOR DIRT ROCKET. The Dirt Rocket has been built to certain Razor design specifications. The original equipment supplied at the time of sale was selected on the basis of its compatibility with the frame, fork and all other parts. Certain aftermarket products may or may not be compatible.

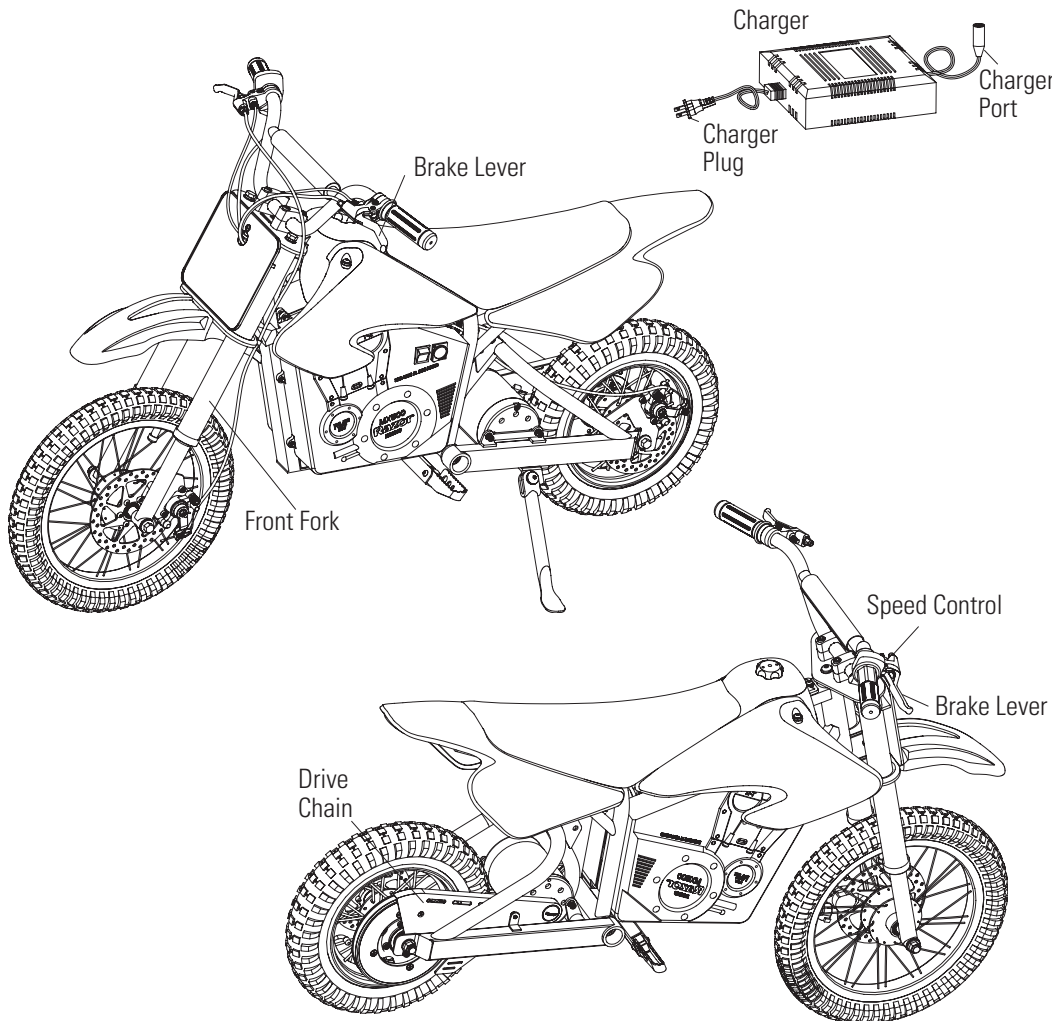

## Required Tools

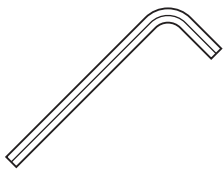

5mm and 6mm key wrenches  
(Included)  
2.5mm key wrench  
(Not Included)

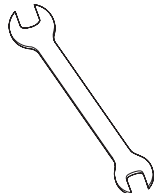

10mm, 14mm and 17mm wrenches  
(Included)  
19mm wrench  
(Not Included)

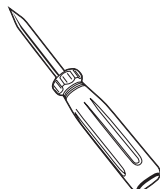

Screwdriver  
(Included)

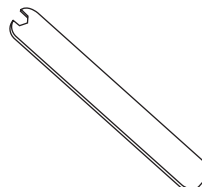

Spoke tightener  
(Included)

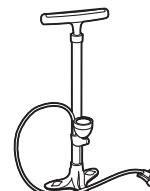

Bicycle-style tire pump  
for Schrader valve tires,  
with pressure gauge  
(Not Included)

**Need Help?** Visit our web site for replacement parts, product support and a list of authorized service centers at [www.razor.com](http://www.razor.com) or call toll-free at **866-467-2967** Monday - Friday 8:00 AM - 5:00 PM Pacific Time.

## ASSEMBLY AND SET-UP

### Attaching the Handlebars

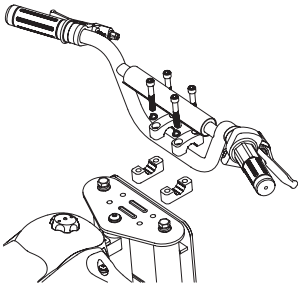

**1** Place the handlebars in the handlebar clamps.

**Note:** Handlebar clamps are located in the plastic bag.

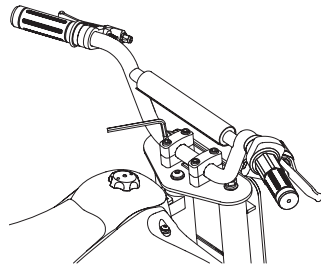

**2** Align parallel to the fork and tighten the bolts using a 6mm L-wrench. When properly tightened, the handlebars should not move forward or back.

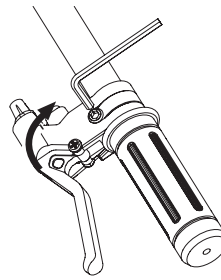

**3** Adjust the brake lever adjuster to the proper place and tighten it with the 5mm key wrench.

### □ Attaching the Front Fender

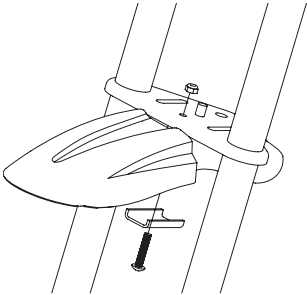

**1** Align fender with the hole in the fork and insert the bolt. Tighten securely using a 10mm Wrench and 5mm Allen Wrench.

### □ Attaching the Number Plate

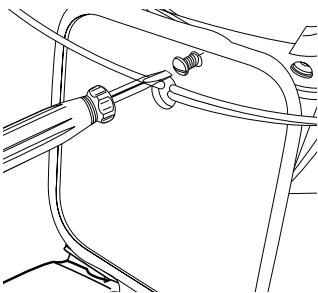

**1** Remove screw from front fork. Align the number plate with the hole in the fork and tighten with a Philipscrew driver.

**Need Help?** Visit our web site for replacement parts, product support and a list of authorized service centers at [www.razor.com](http://www.razor.com) or call toll-free at **866-467-2967** Monday - Friday 8:00 AM - 5:00 PM Pacific Time.



# ASSEMBLY AND SET-UP

## Inflating the Tires

Tires are inflated when shipped, but they invariably lose some pressure between the point of manufacturing and your purchase.

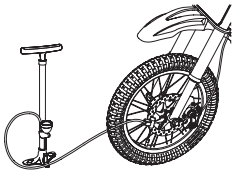

Using a bicycle-style tire pump equipped for a Schrader-type valve, inflate the front tire to the PSI indicated on the sidewall of the tire.

## Testing the Brakes

To use the brakes, squeeze the levers to increase the pressure on the brake. The brake levers are fitted with a cable adjuster to compensate for cable stretch and/or to fine-tune the lever movement to brake engagement. If brakes are not engaging properly, follow instructions for adjusting the brakes outlined below.

## Charging the Battery

Your electric motorbike may not have a fully charged battery; therefore it is a good idea to charge the battery prior to use.

- Initial charge time: 18 hours
- Recharge time: up to 12 hours, depending on the level of charge
- Up to 40 minutes of continuous ride time
- Average battery life: 250 charge/discharge cycles

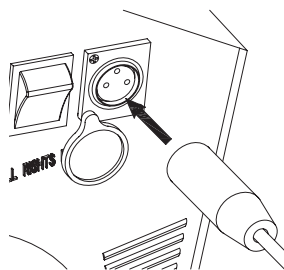
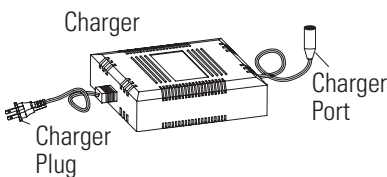

**1** Turn **OFF** power switch before charging. Plug charger into the charger port on the electric motor bike.

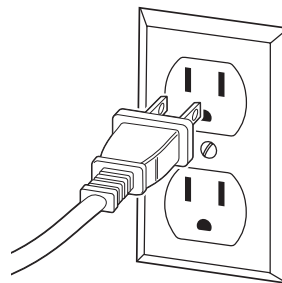

**2** Plug the charger plug into a wall outlet. If the lights on the charger do not light up, check the power to the outlet. If necessary, try a different outlet.

**Note:** The pressurized air supplies found at gasoline stations are designed to inflate high-volume automobile tires. If you decide to use such an air supply to inflate your tires, first make sure the pressure gauge is working, then use very short bursts to inflate to the correct PSI. If you inadvertently over-inflate the tire, release the excess pressure immediately.

## **!** WARNING:

Always disconnect your electric motorbike from the charger before cleaning with liquid.

**Note:** If your charger does not look like the one illustrated, your unit has been supplied with an alternative charger. The specifications and charging procedure would not change.

The charger has a small window with one LED or two LEDs to indicate the charge status. Refer to the illustration on the charger unit for the actual "charging" and "charged" status indications for your model charger.

Chargers have built-in over-charge protection to prevent battery from being over-charged.

Charger will get warm during use. This is normal for some chargers and is no cause for concern. If your charger does not get warm during use, it does not mean that it is not working properly.

**Be sure to properly align the groove on the charger input plug with the corresponding socket on the case; otherwise, no charging action will occur.**

## ASSEMBLY AND SET-UP

### Installing the Front Wheel

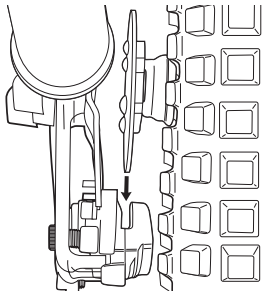

**1** Position wheel in front fork and slide disk brake into caliper.

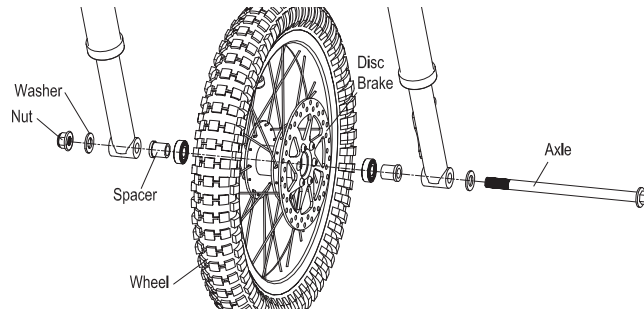

**2** Slide axle through fork, spacer and wheel hub. When axle passes through the other side of the wheel hub, add the other spacer and slide through the fork. Secure with washer and nut.

**Note:** Front axle is installed with the spacer between the fork and wheel for all Dirt Rockets.

**Note:** If your model has one short spacer, it goes on the side of the hub with the disc brake.

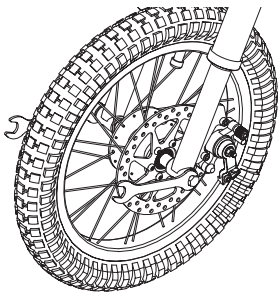

**3** With a 14mm and 17mm wrench tighten the front wheel screws.

## REPAIR AND MAINTENANCE

Check the Razor web site for any updates on the latest repair and maintenance procedures.

**Turn power switch "OFF" before conducting any maintenance procedures.**

### □ Adjusting the Brakes

**Tools required:** 5mm L-wrench

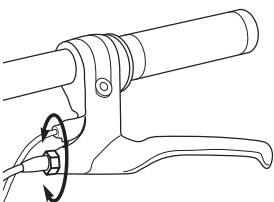

**1** To adjust the play, thread the brake lever adjuster in or out 1/4 to 1/2 turn until the desired brake adjustment is attained. Most adjustments are complete at this step. If brake still needs further adjustment, proceed to step 2 for rear brake.

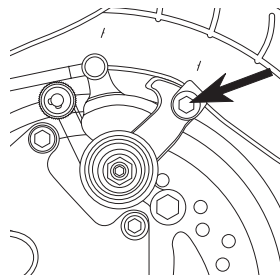

**2** If the brake has too much slack, loosen the rear anchor bolt with a 5mm L-wrench and pull the brake wire tighter. The distance of the brake wire between the end of the cable and the anchor bolt should be between 37mm and 44 mm.

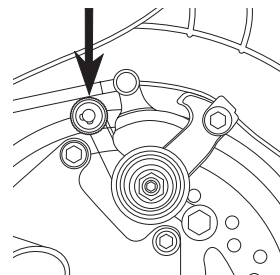

**3** If the brake rotor is dragging on the brake pads, use your fingers to twist the caliper adjuster in either direction until rotor is centered between pads.

### ⚠ WARNING:

Failing to properly adjust and tighten the nuts and bolts that affix the forks can cause you to lose control and fall.

### ⚠ WARNING:

The brake is capable of causing the electric motorbike to skid the tire throwing an unsuspecting rider. Practice in an open area free from obstacles until you are familiar with the brake function. Avoid skidding to a stop as this can cause you to lose control or damage the rear tire.

# REPAIR AND MAINTENANCE

## Chain and Tire Replacement

**Tools required:** Phillips screwdriver and two (2) 19mm wrenches.

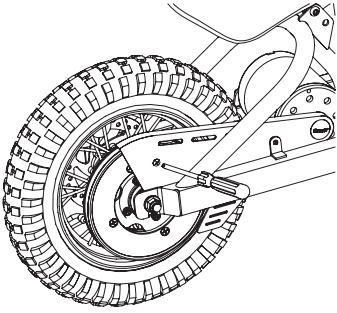

**1** Loosen screw and remove chain guard.

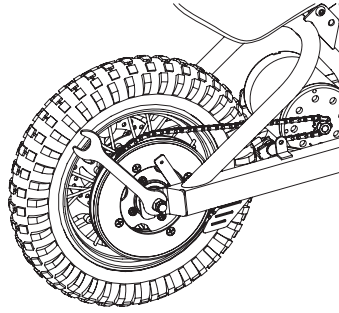

**2** Using two 19mm wrenches, loosen both axle nuts.

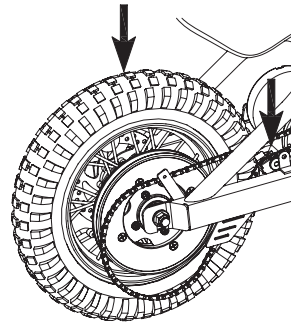

**3** Push the chain tensioner down to loosen the chain and remove the chain from the wheel sprocket and motor sprocket. Push and remove the wheel downward.

**Note:** Your hands will get greasy doing this.

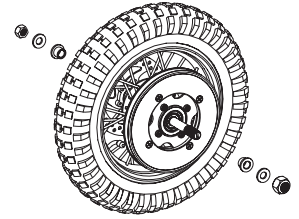

**Note:** the arrangement of the hardware sequence:

### Right Side (Throttle)

Nut  
Washer  
Spacer

### Left Side (Brake)

Nut  
Washer  
Spacer

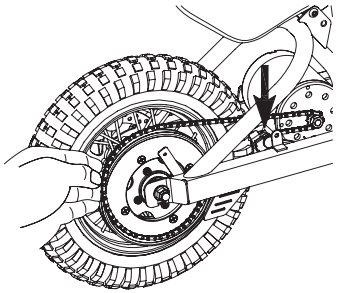

**4** Install the new chain or wheel by slipping the chain around the axle. Slide the axle into the slots on the frame. Slide the chain tensioner down and maneuver the chain onto the rear sprocket and front sprocket.

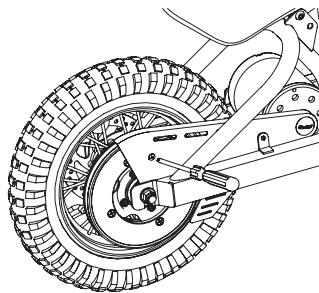

**5** Re-attach the chain guard. Test ride and check. Readjust as needed.

## Replacing the Fuse

3 Fuse boxes

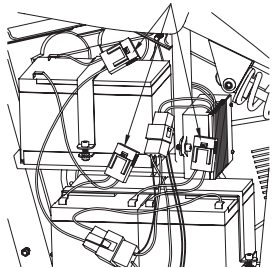

**1** Remove the seat fairing to locate the 3 fuse boxes attached to the batteries.

Fuse checking cavity

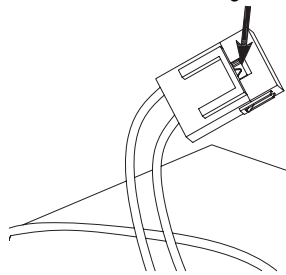

**2** Check all 3 fuses to see if the fuse(s) have burnt out. If the fuse(s) is(are) damaged, open the fuse cover.

Amperage number

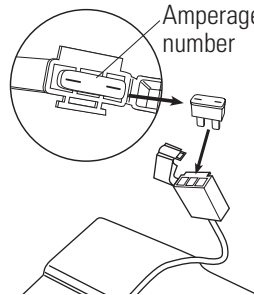

**3** Remove any fuse that is damaged or burnt out and replace with a new one of equal amperage.

**Note:** Amperage is located on top of fuse.

## ⚠ WARNING:

To prevent shock, please follow the instructions accordingly and do not skip any steps.

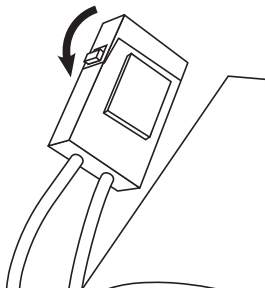

**4** Close the fuse cover and reattach the seat fairing.

## □ Checking Spoke Tension

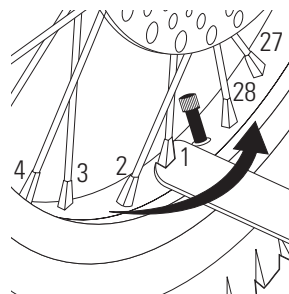
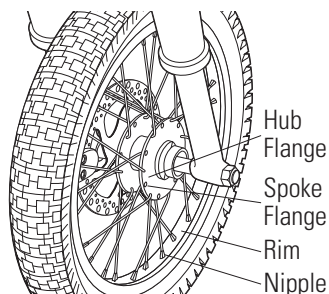
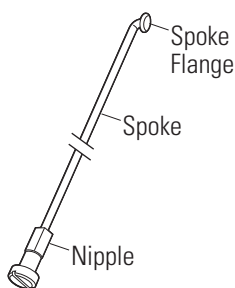

**1** Verify the spoke tension by shaking each spoke with your fingers. Spoke should not be loose from hub. Look for any play between where the spoke flanges attach to the hub. Try to turn the nipple using your fingers. You should not be able to spin any nipple by hand. If one or more spokes is loose, all spokes must be checked and need to be tightened with a spoke wrench.

**2** Start with spoke closest to the tire valve stem and tighten each nipple, in sequence, exactly 1/4 to 1/2 turn. A single 1/4 to 1/2 turn may not be enough to bring the spokes into proper tension. Continue tightening all spokes no more than 1/2 turn in sequence until all spokes are tight.

Note: More than a 1/2 turn each can cause the wheel to become distorted and wobbly thus permanently damaging the wheel.

**⚠ WARNING:**  
Regularly check the spoke tension and retighten the spokes whenever loose. If you have any doubt, ask an experienced motorcycle or bicycle mechanic to inspect your spokes to determine if the spokes need tightening or adjusting.



## REPAIR AND MAINTENANCE

### ❑ Chain and Sprocket

The chain will typically have a “loose spot” and “tight spot” corresponding with a particular sprocket rotational position. This is normal and common to all chain-driven products due to run-out tolerances of the freewheel and sprocket. The chain should be adjusted to the ideal tension with chain in the tightest spot.

Proper chain alignment must be maintained. The wheel must not be skewed. If the chain is noisy or rough running, check the lubrication, tension and alignment of the sprockets, in that order.

### ❑ Battery Care and Disposal

Do not store the battery in temperatures above 75° F or below -10° F.



CONTAINS SEALED NON-SPILLABLE LEAD BATTERIES. BATTERIES MUST BE RECYCLED.

**Disposal:** Your Razor product uses sealed lead-acid batteries which must be recycled or disposed of in an environmentally sound manner. Do not dispose of a lead-acid battery in a fire. The battery may explode or leak. Do not dispose of a lead-acid battery in your regular household trash. The incineration, land filling or mixing of sealed lead-acid batteries with household trash is prohibited by law in most areas. Return exhausted batteries to a federal or state approved lead-acid battery recycler or a local seller of automotive batteries. If you live in Florida or Minnesota, it is prohibited by law to throw away lead-acid batteries in the municipal waste stream.

### ❑ Charger

The charger supplied with the bike should be regularly examined for damage to the cord, plug, enclosure and other parts and in the event of such damage, the Dirt Rocket must not be charged until it has been repaired or replaced.

Use **ONLY** with the recommended charger.

### ❑ Replacement Parts

For a complete selection of replacement parts, visit [www.razor.com](http://www.razor.com).

### ❑ Repair Centers

For a list of authorized Razor repair centers:

- Check online at [www.razor.com](http://www.razor.com).
- Call 866-467-2967 for the center nearest you.

### **WARNING:**

To avoid a pinch or injury, keep fingers away from moving sprockets and chain.

### **WARNING:**

If a battery leak develops, avoid contact with the leaking acid and place the damaged battery in a plastic bag. Refer to the disposal instructions at left. If acid comes into contact with skin or eyes, flush with cool water for at least 15 minutes and contact a physician.

**WARNING:** Battery posts, terminals and related accessories contain lead and lead compounds. **Wash your hands after handling.**

## TROUBLESHOOTING GUIDE

<b>Problem</b>	<b>Possible Cause</b>	<b>Solution</b>
Motor bike does not run	Undercharged battery	<p>Charge the battery. A new battery should have been charged for at least 18 hours before using the motor bike for the first time and up to 12 hours after each subsequent use.</p> <p>Check all connectors. Make sure the charger connector is tightly plugged into the charging port, and that the charger is plugged into the wall.</p> <p>Make sure power flow to the wall outlet is on.</p>
	Loose wires or connectors	Check all wires and connectors to make sure they are tight.
Motor bike was running but suddenly stopped	Burned-out fuse	<p>The fuse will burn out and automatically shut off the power if the motor is overloaded.</p> <p>An excessive overload, such as too heavy a rider or too steep a hill, could cause the motor to overheat. Replace the fuse with a new one of equal amperage. Correct the conditions that caused the fuse to burn out and avoid repeatedly burning out fuse.</p>
	Motor or electrical switch damage	Contact your local Razor authorized service center for diagnosis and repair.
Short run time (less than 15 minutes per charge)	Undercharged battery	<p>Charge the battery. A new battery should have been charged for at least 18 hours before using the motor bike for the first time and up to 12 hours after each subsequent use.</p> <p>Check all wires and connectors. Make sure the battery connector is tightly plugged into the charger connector, and that the charger is plugged into the wall.</p>
	Battery is old and will not accept full charge	Even with proper care, a rechargeable battery does not last forever. Average battery life is 1 to 2 years depending on use of product and conditions. Replace only with a Razor replacement battery.
	Brakes are not adjusted properly	Refer to brake adjustment instructions on page 5 of this manual.
Motor bike runs sluggishly	Riding conditions are too stressful	Use only on solid, flat clean and dry surfaces such as pavement or level ground.
	Tires are not properly inflated	The tires are inflated when shipped, but they invariably will lose some pressure between the point of manufacturing and your purchase. Refer to instructions on page 4 of this manual to properly inflate tires.
	Motor bike is overloaded	Make sure you do not overload the motor bike by allowing more than one rider at one time, exceeding the maximum weight limit, going up too steep a hill or towing objects behind the vehicle.
Sometimes the motor doesn't run, but other times it does	Loose wires or connectors	Check all wires around the motors and all connectors to make sure they are tight.
	Motor or electrical switch damage	Contact your local Razor authorized service center for diagnosis and repair.
Vehicle does not stop when applying the brake	Brakes are not adjusted properly	Refer to instructions on page 5 of this manual to properly adjust brakes.
Vehicle makes loud noises or grinding sounds	Chain is too dry	Apply a lubricant such as 3 in 1™ or Tri-Flow™ to the chain.

# MX500 / MX650 PARTS

Keep your MX500/MX650 running for years with genuine Razor parts. Visit our web site or e-mail us for more information on spare part availability. (Specifications subject to change without notice.)

- |      |                                    |    |                        |      |                            |
|------|------------------------------------|----|------------------------|------|----------------------------|
| 01   | Handlebar grip (right/left)        | 10 | Caliper brake          | 19   | Chain guard                |
| 02   | Twist grip throttle                | 11 | Shock                  | 20   | Battery cover (left/right) |
| 02-1 | Sleeve                             | 12 | Control module         | 21   | On/ Off switch             |
| 03   | Front brake lever assembly (right) | 13 | Battery (3- 12V/ 12Ah) | 22   | Charger port               |
| 04   | Handlebar                          | 14 | Fuse                   | 23   | Seat fairing               |
| 05   | Rear brake lever assembly (left)   | 15 | MX500 motor (36V/500W) | 23-1 | Seat cushion               |
| 06   | Front fork                         |    | MX650 motor (36V/650W) | 23-2 | Front cover (left)         |
| 07   | Front fender                       | 16 | Kickstand              | 23-3 | Front cover (right)        |
| 08   | Handlebar clamp (upper/lower)      | 17 | Rear wheel complete    | 23-4 | Mock gas tank              |
| 09   | Front wheel complete               | 18 | Chain                  | 23-5 | Rear fender                |

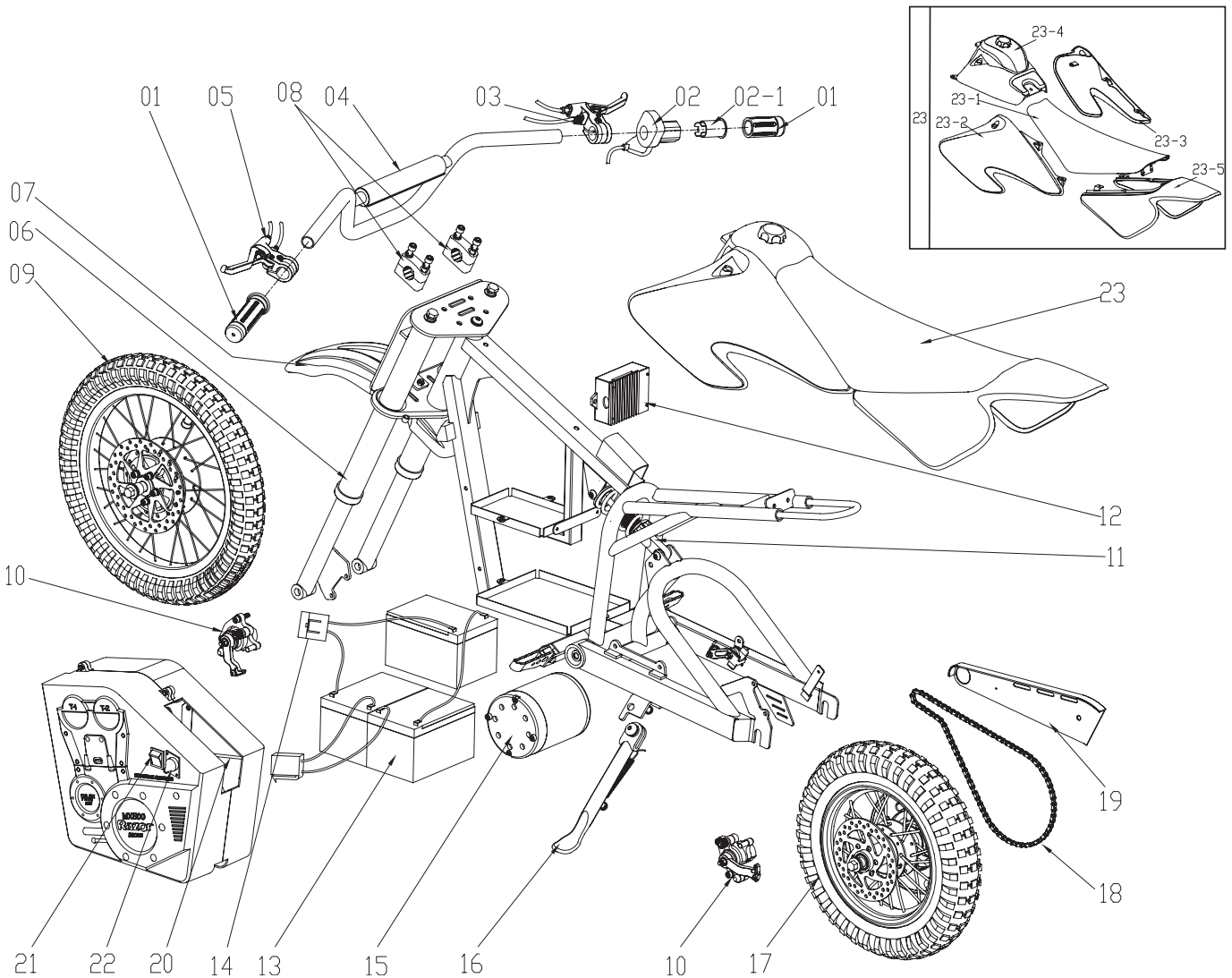

**Need Help?** Visit our web site for replacement parts, product support and a list of authorized service centers at [www.razor.com](http://www.razor.com) or call toll-free at **866-467-2967** Monday - Friday 8:00 AM - 5:00 PM Pacific Time.

**SB 1918 (CALIFORNIA) DECLARATION**

YOUR INSURANCE POLICIES MAY NOT PROVIDE COVERAGE FOR ACCIDENTS INVOLVING THE USE OF THIS SCOOTER/ELECTRIC RIDE-ON PRODUCT. TO DETERMINE IF COVERAGE IS PROVIDED, YOU SHOULD CONTACT YOUR INSURANCE COMPANY OR AGENT.



## SAFETY REMINDERS

### PRE-RIDE CHECKLIST



#### Loose Parts

There should not be any unusual rattles or sounds from loose parts or broken components. If you are not sure, ask an experienced mechanic to check.



#### Brake

Check the brake for proper function. When you squeeze the lever, the brake should provide positive braking action.



#### Frame, Fork and Handlebars

Check for cracks or broken connections. Although broken frames are rare, it is possible for an aggressive rider to run into a curb or wall and wreck and bend or break a frame. Get in the habit of inspecting yours regularly.



#### Tire Inflation

Periodically inspect the tires for excess wear and replace as required, and regularly check the tire pressure and re-inflate as necessary. If you get a flat tire, the inner tube can be patched or a new tube can be purchased from Razor or an authorized repair center.



#### Safety Gear

Always wear proper protective equipment, such as an approved safety helmet, elbow pads and kneepads. Always wear shoes, never ride barefooted or in sandals, and keep shoelaces tied and out of the way of the wheels, motor and drive system.

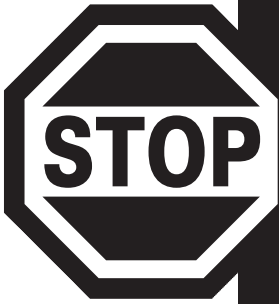

## DO NOT RETURN TO STORE

Do not use this product for the first time until you have inflated the tires to the correct PSI and charged the battery for at least 12 hours.

Failure to follow these instructions may damage your product and void your warranty.

## WARRANTY

### Razor Limited Warranty

The manufacturer warrants this product to be free of manufacturing defects for a period of 90 days from date of purchase. This Limited Warranty does not cover normal wear and tear, tires, tubes or cables, or any damage, failure or loss caused by improper assembly, maintenance, or storage or use of the Razor Dirt Rocket.

This Limited Warranty will be void if the product is ever:

- used in a manner other than for recreation;
- modified in any way;
- rented.

The manufacturer is not liable for incidental or consequential loss or damage due directly or indirectly to the use of this product.

Razor does not offer an extended warranty. If you have purchased an extended warranty, it must be honored by the store at which it was purchased.

For your records, save your original sales receipt with this manual and write the serial number below.

Item Numbers:

**MX500 15128190**

**MX650 15165070**

**Need Help?** Visit our web site for replacement parts, product support and a list of authorized service centers at [www.razor.com](http://www.razor.com) or call toll-free at **866-467-2967** Monday - Friday 8:00 AM - 5:00 PM Pacific Time.

Printed in China for:  
Razor USA LLC  
PO Box 3610  
Cerritos, CA 90703

Copyright © 2003 - 2009 Razor USA LLC. All rights reserved. RAZOR and the Razor Logo Design are among the registered trademarks of Razor USA LLC in the United States and/or select foreign countries.